



FRAZER MED INSTRUMENTS

MANUFACTURER & EXPORTER
OF SURGICAL, DENTAL INSTRUMENTS
AND ALLIED BRANCHES



ABOUT US

Frazer Med Instruments was formed to create a brand of surgical instruments that utilised the experience and expertise of many of the craftsmen within the surgical arena. We deal in Surgical instruments, Neuro instruments, Orthopedic instruments, Plastic surgical trays, Dental instruments and Examination / Suture Practice Kits.

www.frazermed.com

Info@frazermed.com

General Instruments

Artery Forceps	03
Clamps	06
Spring Forceps	07
Tissue Forceps	09
Sponge Holding and Sterilising Forceps	11
Other Forceps	12
Scissors	13
Needle Holders	18
Combined Scissor and Needle Holders	22
Bag and Towel Clips	23
Retractors	24
Dissectors and Probes	32
Miscellaneous	33
Hollow Ware	34
Silicone Matting	35
Wire Sterilising Baskets	36



Adson Artery Forceps

Box joint, 180mm long

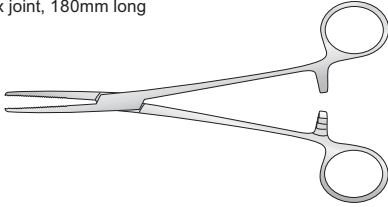

Serrated jaws

Code	Description
FMI-GI/034	Straight
FMI-GI/034a	Curved

1-2 teeth

Code	Description
FMI-GI/034b	Straight
FMI-GI/034c	Curved

Cushing Artery Forceps

Box joint, fine, half serrated jaws, 140mm long

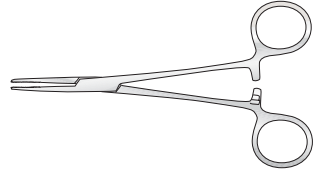

Code	Description
FMI-GI/001	Straight
FMI-GI/002	Curved

Cairns Artery Forceps

Box joint, half serrated jaws
145mm long

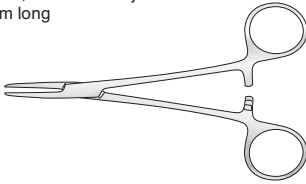

Serrated jaws

Code	Description
FMI-GI/415	Straight

1-2 teeth

Code	Description
FMI-GI/020	Curved
FMI-GI/021	Curved to side

Dunhill Artery Forceps

Box joint, fine serrations

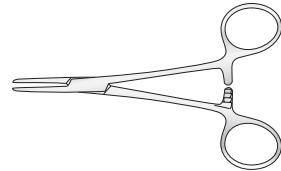

Straight

Code	Description
FMI-GI/065	135mm long
FMI-GI/065a	190mm long

Curved

Code	Description
FMI-GI/043	135mm long
FMI-GI/468	180mm long

Crile Artery Forceps

Box joint, serrated jaws

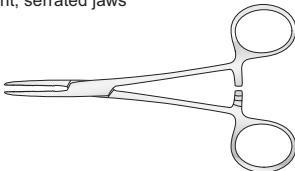

Straight

Code	Description
FMI-GI/014	140mm long
FMI-GI/014a	160mm long

Curved

Code	Description
FMI-GI/015	140mm long
FMI-GI/015a	160mm long

Lawson Tait Artery Forcep

Box joint, straight jaw

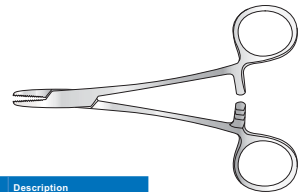

Code	Description
FMI-GI/SH5924	140mm long

Halstead Mosquito Forceps

Standard pattern, haemostatic, box joint

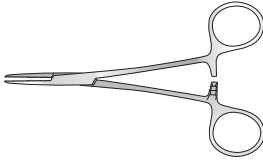

Serrated jaw

Code	Description
FMI-GI/007	Straight 125mm long
FMI-GI/008	Curved 125mm long
FMI-GI/009	Fully curved 125mm long

1-2 teeth

Code	Description
FMI-GI/010	Straight 125mm long
FMI-GI/012	Straight 190mm long
FMI-GI/011	Curved 125mm long
FMI-GI/013	Curved 190mm long

Micro, 100mm long

Code	Description
FMI-GI/003	Straight, serrated
FMI-GI/004	Curved, serrated
FMI-GI/005	Straight, 1-2 teeth
FMI-GI/006	Curved, 1-2 teeth

Kelly Artery Forceps

Box joint, half serrated jaws



Straight

Code	Description
FMI-GI/022	140mm long
FMI-GI/023	160mm long

Curved

Code	Description
FMI-GI/024	140mm long
FMI-GI/025	180mm long

Fraser Kelly Artery Forceps Curved

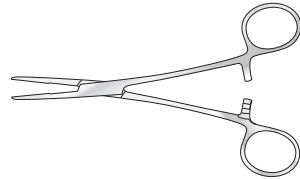

Straight

Code	Description
FMI-GI/468a	180mm

Heiss Artery Forceps

Box joint, 205mm long

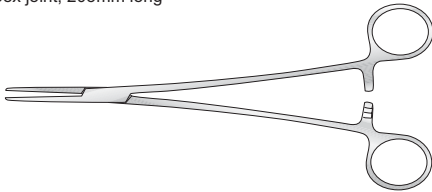

Serrated jaws

Code	Description
FMI-GI/016	Straight
FMI-GI/017	Curved

1-2 teeth

Code	Description
FMI-GI/016a	Straight
FMI-GI/017b	Curved

Kocher Artery Forceps

Box joint, 1-2 teeth

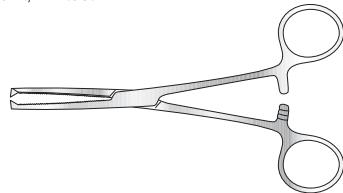

Straight

Code	Description
FMI-GI/052	130mm long
FMI-GI/053	150mm long
FMI-GI/054	180mm long
FMI-GI/055	200mm long
FMI-GI/056	230mm long

Curved

Code	Description
FMI-GI/057	150mm long
FMI-GI/058	180mm long
FMI-GI/059	200mm long
FMI-GI/060	230mm long

Moynihan Artery Forceps

Box joint, half-serrated jaws

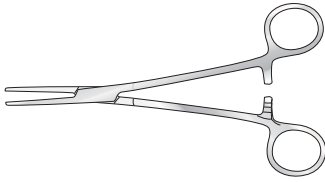

Straight

Code	Description
FMI-GI/018	145mm long
FMI-GI/068	180mm long

Curved

Code	Description
FMI-GI/019	145mm long
FMI-GI/069	180mm long

Rochester-Pean Artery Forceps

Box joint

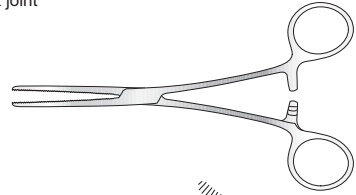

Straight

Code	Description
FMI-GI/044	165mm long
FMI-GI/045	190mm long
FMI-GI/046	205mm long
FMI-GI/047	240mm long

Curved

Code	Description
FMI-GI/048	165mm long
FMI-GI/049	180mm long
FMI-GI/050	205mm long
FMI-GI/051	240mm long

Roberts Artery Forceps

Screw joint, curved on flat, serrated

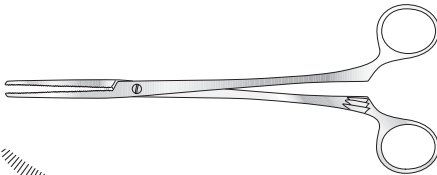

Code	Description
FMI-GI/070	230mm long

Spencer Wells Artery Forceps

Box joint, serrated jaws

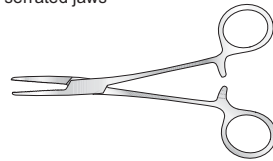

Straight

Code	Description
FMI-GI/035	127mm long
FMI-GI/038	152mm long
FMI-GI/037	177mm long
FMI-GI/038	203mm long

Curved

Code	Description
FMI-GI/039	127mm long
FMI-GI/040	152mm long
FMI-GI/041	177mm long
FMI-GI/042	203mm long

Dandy Artery Forceps

Box joint, curved in plane

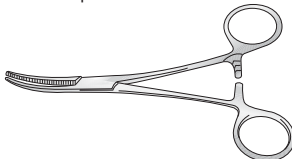

Code	Description
FMI-GI/076	140mm long

Carmalt Angiotribe Forceps

Box joint, atraumatic, light pattern

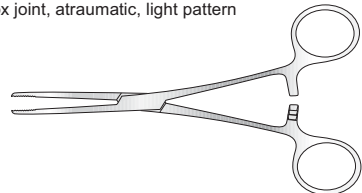

Straight

Code	Description
FMI-GI/062	165mm long
FMI-GI/063	200mm long
FMI-GI/064	230mm long

Curved

Code	Description
FMI-GI/061	165mm long

Dieffenbach Bulldog Clamp

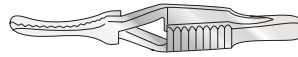

Straight, serrated

Code	Description
FMI-GI/112	1.2mm fine jaw, 40mm long
FMI-GI/113	1.2mm fine jaw, 45mm long
FMI-GI/108	1.8mm jaw, 30mm long
FMI-GI/109	1.8mm jaw, 35mm long
FMI-GI/110	2.5mm jaw, 40mm long
FMI-GI/111	2.5mm jaw, 45mm long
FMI-GI/107	6mm heavy jaw, 60mm long
FMI-GI/455	20mm jaw, 75mm long
FMI-GI/455a	30mm jaw, 85mm long
FMI-GI/455b	45mm jaw, 105mm long
FMI-GI/455c	65mm jaw, 120mm long

Straight, plain

Code	Description
FMI-GI/129	1.2mm fine jaw, 40mm long
FMI-GI/131	1.2mm fine jaw, 45mm long
FMI-GI/121	1.8mm jaw, 30mm long
FMI-GI/123	1.8mm jaw, 35mm long
FMI-GI/125	2.5mm jaw, 40mm long
FMI-GI/127	2.5mm jaw, 45mm long

Curved, serrated

Code	Description
FMI-GI/119	1.2mm fine jaw, 40mm long
FMI-GI/120	1.2mm fine jaw, 45mm long
FMI-GI/115	1.8mm jaw, 30mm long
FMI-GI/116	1.8mm jaw, 35mm long
FMI-GI/117	2.5mm jaw, 40mm long
FMI-GI/118	2.5mm jaw, 45mm long
FMI-GI/114	6mm heavy jaw, 60mm long
FMI-GI/456	20mm jaw, 75mm long
FMI-GI/456a	30mm jaw, 85mm long
FMI-GI/456b	45mm jaw, 105mm long
FMI-GI/456c	65mm jaw, 120mm long

Curved, plain

Code	Description
FMI-GI/130	1.2mm fine jaw, 40mm long
FMI-GI/132	1.2mm fine jaw, 45mm long
FMI-GI/122	1.8mm jaw, 30mm long
FMI-GI/124	1.8mm jaw, 35mm long
FMI-GI/126	2.5mm jaw, 40mm long
FMI-GI/128	2.5mm jaw, 45mm long

Blalock Bulldog Clamp



Serrated, with hole in handle

Straight

Code	Description
FMI-GI/480	11mm jaw, 38mm long
FMI-GI/482	14mm jaw, 48mm long
FMI-GI/493	17mm jaw, 60mm long
FMI-GI/481	27mm jaw, 70mm long

Curved

Code	Description
FMI-GI/478	11mm jaw, 38mm long
FMI-GI/479	14mm jaw, 48mm long
FMI-GI/491	17mm jaw, 60mm long
FMI-GI/492	27mm jaw, 70mm long

Plain, with hole in handle

Straight

Code	Description
FMI-GI/486	11mm jaw, 38mm long
FMI-GI/487	14mm jaw, 48mm long
FMI-GI/488	17mm jaw, 60mm long
FMI-GI/489	27mm jaw, 70mm long

Curved

Code	Description
FMI-GI/483	11mm jaw, 38mm long
FMI-GI/484	14mm jaw, 48mm long
FMI-GI/485	17mm jaw, 60mm long
FMI-GI/490	27mm jaw, 70mm long

An Overview On

Forcep Jaw Types

You will see that forceps in our catalogue will have either a traditional serrated jaw or a different design which is known as atraumatic (or non-traumatic).

Traditional Serrated Jaw



The traditional serrated jaw is generally more robust and used on forceps where the areas are not as delicate.

Atraumatic Jaw



Atraumatic jaws will be mainly found in delicate surgery areas such as vascular and cardiothoracic. The design is such, that the surface area gripped is reduced, ensuring less trauma without the loss of grip.

Adsons Dissecting Forceps

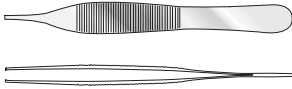

127mm long

Code	Description
FMI-GI/257	1-2 teeth
FMI-GI/258	Lightweight, micro
FMI-GI/259	Serrated
FMI-GI/260	Serrated, lightweight, micro

Block End Dissecting Forceps

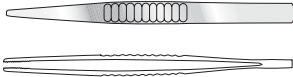

Serrated

Code	Description
FMI-GI/255	127mm long
FMI-GI/256	152mm long
FMI-GI/256a	203mm long

Bonney Dissecting Forceps

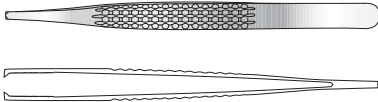

178mm long

Code	Description
FMI-GI/267	Serrated, 1-2 teeth
FMI-GI/268	1-2 teeth

Charnley-McIndoe Dissecting Forceps

150mm long

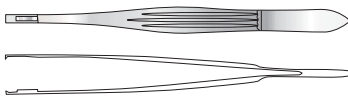

Code	Description
FMI-OR/N045a	2-3 teeth

DeBakey Atraumatic Dissecting Forceps

Straight, atraumatic jaws

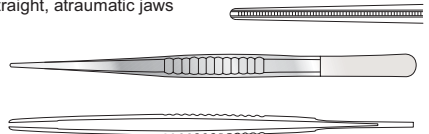

1.5mm

Code	Description
FMI-GI/238a	150mm long
FMI-GI/240a	240mm long

2.5mm

Code	Description
FMI-GI/238b	150mm long
FMI-GI/240b	240mm long

2mm

Code	Description
FMI-GI/238	150mm long
FMI-GI/241	180mm long

2.8mm

Code	Description
FMI-GI/238c	150mm long
FMI-GI/240c	240mm long
FMI-GI/241c	180mm long

Dissecting Forceps

Turnover end, serrated jaws

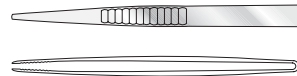

Code	Description
FMI-GI/242	127mm long
FMI-GI/243	152mm long

Code	Description
FMI-GI/244	178mm long
FMI-GI/245	203mm long

Dunhill Dissecting Forceps

Light, fine serrated jaws



Code	Description
FMI-GI/457	145mm long

Fredrick Coole Dissecting Forceps

Extra fine serrated jaws

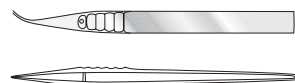

125mm long

Code	Description
FMI-GI/066	Straight
FMI-GI/067	Curved

Gillies Dissecting Forceps

1-2 teeth

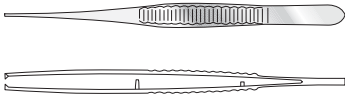

Code	Description
FMI-PL/052	152mm long

McIndoe Dissecting Forceps

152mm long

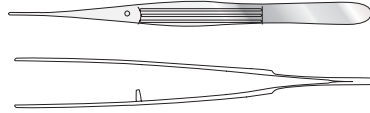

Code	Description
FMI-GI/476	Serrated
FMI-GI/477	1-2 teeth

Jackson Burrows Dissecting Forceps

140mm long

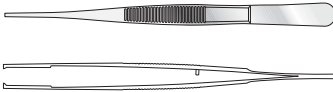

Code	Description
FMI-OR/N037	Tongue and groove, 1-2 teeth
FMI-OR/N037a	Tongue and groove only

McIndoe Modified Dissecting Forceps

152mm long, 1mm tip, modified for fine powerful dissection with strong action tip

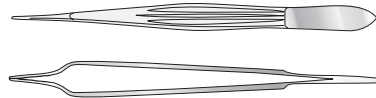

Code	Description
SH/5961	Serrated

Jean Dissecting Forceps

Serrated jaws, 140mm long

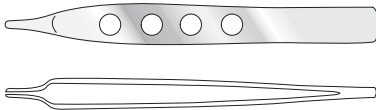

Code	Description
FMI-GI/269	Fine
FMI-GI/270	1-2 teeth
FMI-GI/271	2-3 teeth, 178mm long

Treves Dissecting Forceps

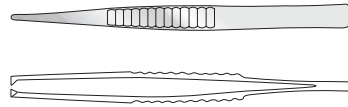

1-2 teeth

Code	Description
FMI-GI/251	127mm long
FMI-GI/252	152mm long

2-3 teeth

Code	Description
FMI-GI/253	127mm long
FMI-GI/254	152mm long

Lanes Dissecting Forceps

1-2 teeth on serrated jaws, 140mm long

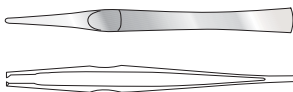

Code	Description
FMI-GI/246	127mm long
FMI-GI/247	152mm long
FMI-GI/248	178mm long

Code	Description
FMI-GI/249	2-3 teeth, 178mm long
FMI-GI/250	2-3 teeth 203mm long

Waugh Dissecting Forceps

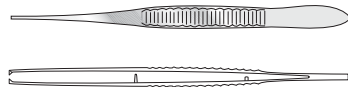

Fine, serrated

Code	Description
FMI-GI/261	152mm long
FMI-GI/262	178mm long
FMI-GI/263	203mm long

Fine, 1-2 teeth

Code	Description
FMI-GI/264	152mm long
FMI-GI/265	178mm long
FMI-GI/266	203mm long

Allis Tissue Forceps

Box joint

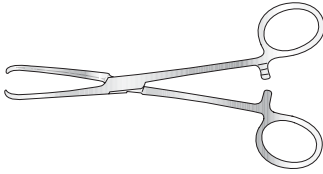

150mm long

Code	Description
FMI-GI/272	3-4 teeth
FMI-GI/273	4-5 teeth

190mm long

Code	Description
FMI-GI/414	5-6 teeth

Duval Tissue Forceps

Box joint

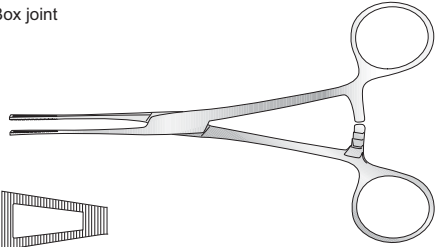

Code	Description
FMI-GI/279	13mm wide, 203mm long

Littlewood Tissue Forceps

Box joint, 2-3 teeth

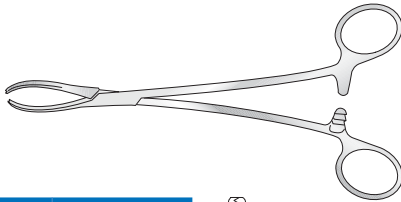

Code	Description
FMI-GI/275	190mm long

Lane Tissue Forceps

Box joint, 1-2 teeth, fenestrated

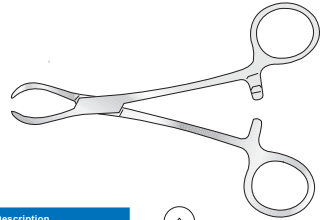

Code	Description
FMI-GI/280	127mm long
FMI-GI/281	152mm long
FMI-GI/282	197mm long

Babcock Tissue Forceps

Box joint, serrated jaws

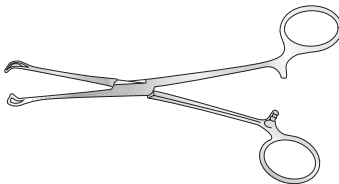

Code	Description
FMI-GI/276	160mm long
FMI-GI/277	200mm long
FMI-GI/278	230mm long

Rutherford Morrison Tissue Forceps

Box joint

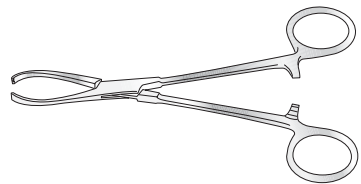

Code	Description
FMI-GI/283	4-5 teeth, 152mm long

Shaw Tissue Forceps

Box joint

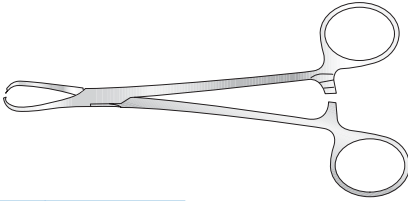

Code	Description
FMI-GI/458	1-2 teeth, 178mm long



Guys Gallabin Suture-Holding Forceps

Screw joint, angled flat blades

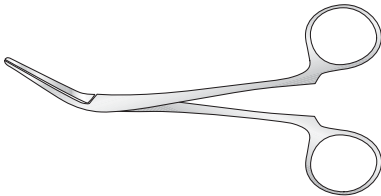

Code	Description
FMI-GI/450	125mm long
FMI-GI/4402	150mm long

Russian Dissecting Forceps

With fenestrated end

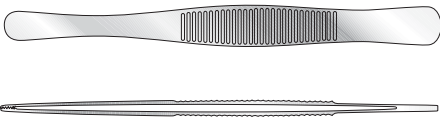

Code	Description
FMI-GI/SH-5503b	150mm long
FMI-GI/SH-5503	200mm long
FMI-GI/403	230mm long
FMI-GI/SH-5503a	250mm long



Special Offer

on SSD Essentials Pack

Halstead Mosquito Forceps

Straight/Curved
125mm (5")

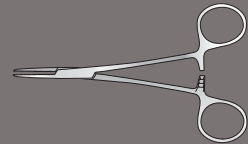

Rampléy Sponge Holding Forceps

Straight, Serrated
Jaws 241mm
(9½")

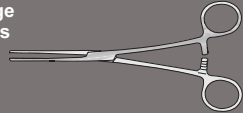

Scalpel Blade Handle

No. 3



Spring Clip

Serrated Pattern,
Stainless Steel for
Fixing Slings to Leg
Splints, also for
Towel Clipping
6.3cm (2½") Wide

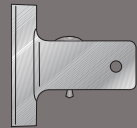

Spencer Wells Artery Forceps

Straight, Serrated
Jaws

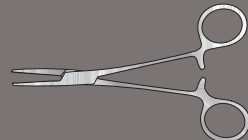

Rampley Sponge Holding Forceps

Box joint, straight, serrated jaws

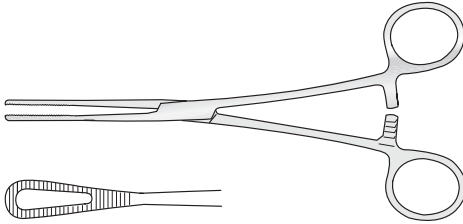

Code	Description
FMI-GI/353	178mm long
FMI-GI/354	241mm long

Lister Sinus Forceps

Box joint, serrated tip

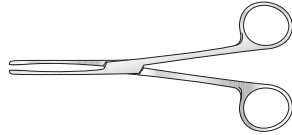

Code	Description
FMI-GI/367	127mm long
FMI-GI/368	152mm long
FMI-GI/369	178mm long

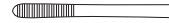

Foerster Sponge Holding Forceps

Box joint, straight, serrated jaws

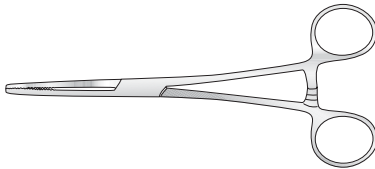

Code	Description
FMI-GI/354a	178mm long

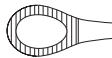

Cheate Sterilizer Forceps

Screw joint

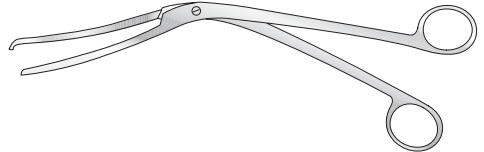

Code	Description
FMI-GI/364	267mm long

Harrison Bowl Steriliser Forceps

Screw joint, angled, double jaw

Code	Description
FMI-GI/365	356mm long
FMI-GI/366	457mm long

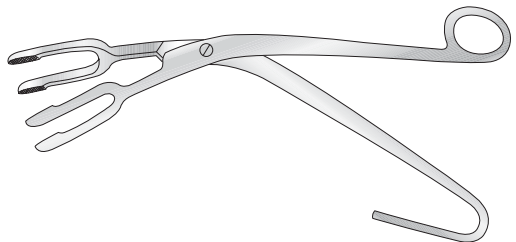

Hunter Splinter Forceps

Serrated grooved pointed jaws



Code	Description
FMI-GI/360	115mm long

Michel Forceps

Box joint, double-ended, for inserting and removing clips stainless steel

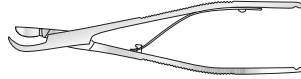

Code	Description
FMI-GI/357	130mm long

Michel Skin Holding Forceps

With magazine for Michel clips

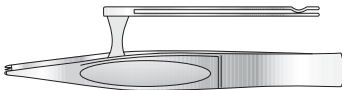

Code	Description
FMI-GI/358	1-2 teeth, 127mm long

Michel Clip Extracting Forceps

Box joint

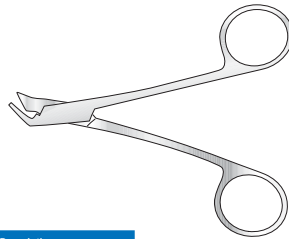

Code	Description
FMI-GI/359	125mm long

Childe Approximating Forceps

With magazine for Michel clips

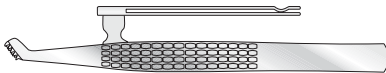

Code	Description
FMI-GI/469	180mm long

Robins Anchoring Forceps

140mm long

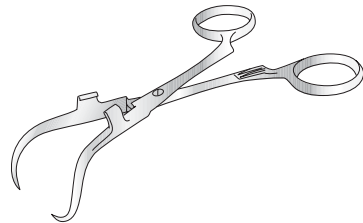

Code	Description
FMI-GI/453	5mm with holder for diathermy leads
FMI-GI/453a	13mm with holder for suction tubing

Dressing Scissors

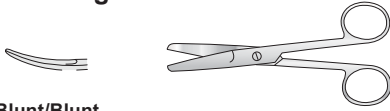

Blunt/Blunt

Straight

Code	Description
FMI-GI/133	130mm long
FMI-GI/136	146mm long
FMI-GI/139	165mm long

Curved

Code	Description
FMI-GI/142	130mm long
FMI-GI/143	146mm long
FMI-GI/144	165mm long
FMI-GI/145	185mm long
FMI-GI/404	147mm long

With one serrated blade

Blunt/Sharp

Straight

Code	Description
FMI-GI/134	130mm long
FMI-GI/137	146mm long
FMI-GI/140	165mm long

Sharp/Sharp

Straight

Code	Description
FMI-GI/135	130mm long
FMI-GI/138	146mm long
FMI-GI/141	165mm long

Curved

Code	Description
FMI-GI/146	130mm long

Dressing Scissors, Left-Handed

With one black bow, 145mm long

Blunt/Blunt

Code	Description
FMI-GI/192	Straight
FMI-GI/193	Curved

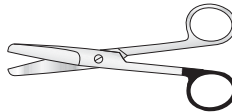

Blunt/Sharp

Code	Description
FMI-GI/194	Straight
FMI-GI/195	Curved

Sharp/Sharp

Code	Description
FMI-GI/196	Straight
FMI-GI/197	Curved

Littler Dissecting Scissors

Fine pattern, with eye for suture

Code	Description
FMI-PL/001f	115mm long

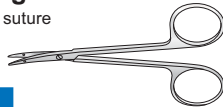

Kilner Dissecting Scissors

Fine pattern

Code	Description
FMI-PL/001d	115mm long

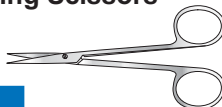

Metzenbaum Scissors

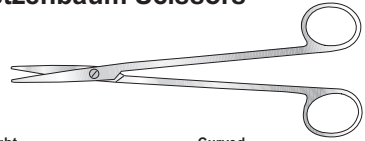

Straight

Code	Description
FMI-GI/405	180mm long
FMI-GI/406	147mm long
FMI-GI/406a	200mm long
FMI-GI/406b	230mm long
FMI-GI/406c	250mm long
FMI-GI/406d	280mm long

Curved

Code	Description
FMI-GI/407	185mm long
FMI-GI/408	147mm long
FMI-GI/408a	200mm long
FMI-GI/408b	230mm long
FMI-GI/408c	250mm long
FMI-GI/408d	280mm long

Mayo Scissors

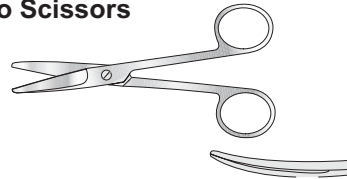

Straight

Code	Description
FMI-GI/409	140mm long
FMI-GI/409a	160mm long
FMI-GI/411	190mm long
FMI-GI/411a	230mm long

Curved

Code	Description
FMI-GI/410	140mm long
FMI-GI/410a	160mm long
FMI-GI/412	190mm long
FMI-GI/412a	230mm long

Ferguson Scissors

Angled on flat

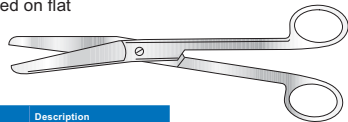

Code	Description
FMI-GI/148	180mm long

Paynes Suture Scissors

Code	Description
FMI-GI/152	100mm long

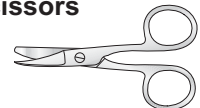

Ligature Stitch Scissors

Fine pattern

Code	Description
FMI-GI/153	115mm long

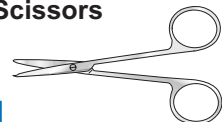

Lister Bandage Scissors

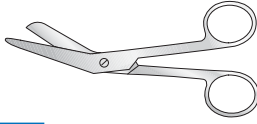

Code	Description
FMI-GI/154	147mm long
FMI-GI/155	178mm long

Lister Bandage Scissors

Angled, with probe end

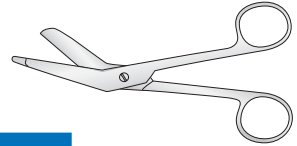

Code	Description
FMI-GI/361	147mm long
FMI-GI/362	178mm long

McIndoe Scissors

178mm long

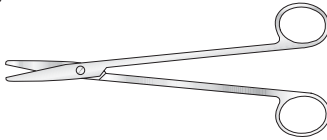

Code	Description
FMI-GI/149	Straight
FMI-GI/150	Curved on flat
FMI-GI/150a	Supercut, curved



Thomas Strabismus Scissors

114mm long

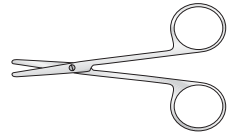

Code	Description
FMI-OP/030	Straight
FMI-OP/029	Curved

Heath Stitch Scissors

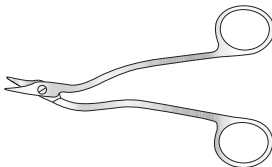

Code	Description
FMI-GI/151	152mm long

“Careless” Scissors

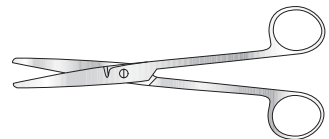

Code	Description
FMI-GI/474	165mm long

Tubing Scissors

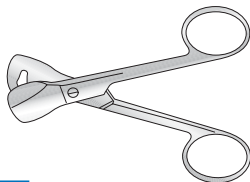

Code	Description
FMI-GI/147	130mm long

Utility Scissors



Code	Description
FMI-GI/466	190mm long

Dressing Scissors

Tungsten carbide hard insert, blunt/blunt

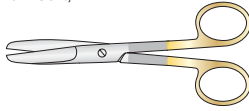

Straight

Code	Description
FMI-GI/430	130mm long
FMI-GI/432	145mm long
FMI-GI/434	165mm long
FMI-GI/436	185mm long

Curved

Code	Description
FMI-GI/431	130mm long
FMI-GI/433	145mm long
FMI-GI/435	165mm long

Mayo Dressing Scissors

Tungsten carbide hard insert

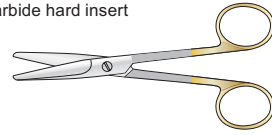

Straight

Code	Description
FMI-GI/419	140mm long
FMI-GI/419a	160mm long
FMI-GI/421	190mm long
FMI-GI/421a	230mm long

Curved

Code	Description
FMI-GI/420	140mm long
FMI-GI/420a	160mm long
FMI-GI/422	190mm long
FMI-GI/422a	230mm long

Dressing Scissors

Tungsten carbide hard insert, blunt/sharp

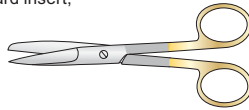

Straight

Code	Description
FMI-GI/423	130mm long
FMI-GI/425	145mm long
FMI-GI/427	165mm long
FMI-GI/429	185mm long

Curved

Code	Description
FMI-GI/424	130mm long
FMI-GI/426	145mm long
FMI-GI/428	165mm long

Mayo-Harrington Dressing Scissors

Tungsten carbide hard insert

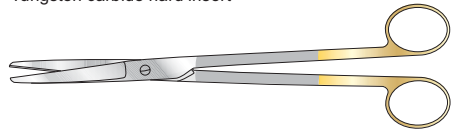

230mm long

Code	Description
FMI-GI/417	Straight
FMI-GI/418	Curved

200mm long

Code	Description
FMI-GI/162a	Straight
FMI-GI/113b	Curved

Dressing Scissors

Tungsten carbide hard insert sharp/sharp

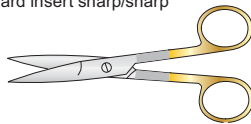

Straight

Code	Description
FMI-GI/437	130mm long
FMI-GI/439	145mm long
FMI-GI/441	165mm long
FMI-GI/443	185mm long

Curved

Code	Description
FMI-GI/438	130mm long
FMI-GI/440	145mm long
FMI-GI/442	165mm long

Metzenbaum Scissors

Tungsten carbide hard insert

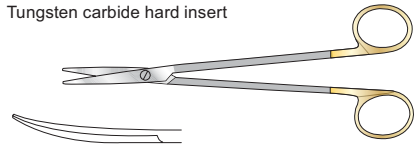

230mm long

Code	Description
FMI-GI/445	145mm long
FMI-GI/448	185mm long
FMI-GI/471a	230mm long
FMI-GI/471b	250mm long
FMI-GI/471c	280mm long

200mm long

Code	Description
FMI-GI/446	145mm long
FMI-GI/449	185mm long
FMI-GI/449a	200mm long
FMI-GI/449b	230mm long
FMI-GI/449c	250mm long
FMI-GI/449d	280mm long

Baby Metzenbaum Scissors

Tungsten carbide, hard insert, 145mm long

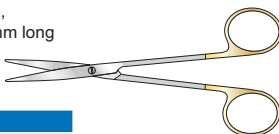

Code	Description
FMI-GI/445a	Straight
FMI-GI/446a	Curved

Ligature Scissors

Tungsten carbide hard insert, curved

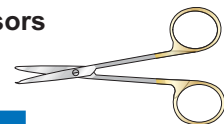

Code	Description
FMI-GI/444	145mm long
FMI-GI/447	185mm long

Mayo Harrington Scissors

Supercut, tungsten carbide

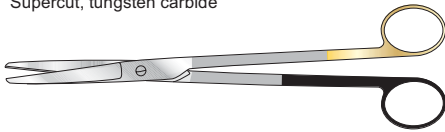

230mm long

Code	Description
FMI-GI/162	Straight
FMI-GI/1413	Curved

200mm long

Code	Description
FMI-GI/162b	Straight
FMI-GI/1413b	Curved

Dressing Scissors

Supercut, tungsten carbide

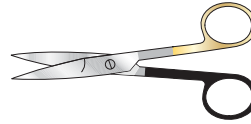

Blunt/Blunt

Straight

Code	Description
FMI-GI/174	130mm long
FMI-GI/176	145mm long
FMI-GI/178	165mm long
FMI-GI/180	185mm long

Curved

Code	Description
FMI-GI/175	130mm long
FMI-GI/177	145mm long
FMI-GI/179	165mm long
FMI-GI/180a	185mm long

Mayo Scissors

Supercut, tungsten carbide

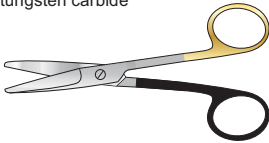

Straight

Code	Description
FMI-GI/163	140mm long
FMI-GI/163a	160mm long
FMI-GI/165	190mm long
FMI-GI/165a	230mm long

Curved

Code	Description
FMI-GI/164	140mm long
FMI-GI/164a	160mm long
FMI-GI/166	190mm long
FMI-GI/166a	230mm long

Blunt/Sharp

Straight

Code	Description
FMI-GI/167	130mm long
FMI-GI/169	145mm long
FMI-GI/171	165mm long
FMI-GI/173	185mm long

Curved

Code	Description
FMI-GI/168	130mm long
FMI-GI/170	145mm long
FMI-GI/172	165mm long
FMI-GI/173a	185mm long

Sharp/Sharp

Straight

Code	Description
FMI-GI/181	130mm long
FMI-GI/183	145mm long
FMI-GI/185	165mm long
FMI-GI/187	185mm long

Curved

Code	Description
FMI-GI/182	130mm long
FMI-GI/184	145mm long
FMI-GI/186	165mm long
FMI-GI/187a	185mm long

Metzenbaum Dissecting Scissors

Supercut, tungsten carbide



Straight

Code	Description
FMI-GI/188tc	185mm long
FMI-GI/188tca	200mm long
FMI-GI/188tcb	230mm long
FMI-GI/188tcc	250mm long
FMI-GI/188tcd	280mm long

Curved

Code	Description
FMI-GI/191tc	147mm
FMI-GI/189tc	185mm
FMI-GI/188tca	200mm
FMI-GI/188tcb	230mm
FMI-GI/188tcc	250mm
FMI-GI/188tcd	280mm

Guide for Gold and Black Bows

It's important to know the difference for the intended use of each scissor:



2 Gold Bows
Tungsten carbide insert or padding for a scissor



2 Black Bows
Supercut edge



1 Black and 1 Gold Bow
Supercut tungsten carbide



1 Black Bow (left ring)
Left-handed instrument carbide

Dressing Scissors

Supercut, blunt/blunt

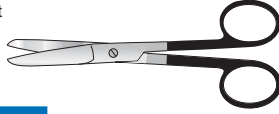

145mm long

Code	Description
FMI-GI/160	Straight
FMI-GI/161	Curved

Dressing Scissors

Supercut, blunt/sharp



145mm long

Code	Description
FMI-GI/156	Straight
FMI-GI/157	Curved

Dressing Scissors

Supercut, sharp/sharp



145mm long

Code	Description
FMI-GI/158	Straight
FMI-GI/159	Curved

Mayo Scissors

Supercut



Straight

Code	Description
FMI-GI/166a	140mm long
FMI-GI/166c	160mm long
FMI-GI/166b	170mm long

Curved

Code	Description
FMI-GI/166c	140mm long
FMI-GI/166f	160mm long
FMI-GI/166d	170mm long

Boyd Scissors

Supercut, blunt/blunt

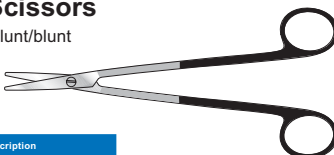

Code	Description
FMI-THO/047	180mm long

Metzenbaum Dissecting Scissors

Supercut

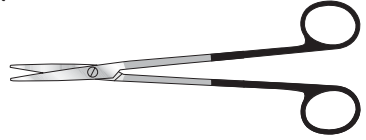

Straight (length)

Code	Description
FMI-GI/190	147mm
FMI-GI/188	185mm
FMI-GI/188a	200mm
FMI-GI/188b	230mm
FMI-GI/188c	250mm
FMI-GI/188d	280mm

Curved (length)

Code	Description
FMI-GI/191	147mm
FMI-GI/189	185mm
FMI-GI/186a	200mm
FMI-GI/186b	230mm
FMI-GI/186c	250mm
FMI-GI/186d	280mm

Stevens Tenotomy Scissors

Supercut

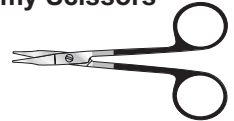

Curved/blunt

Code	Description
FMI-OP/24	114mm long
FMI-OP/24a	125mm long
FMI-OP/24gb	135mm long

Curved/sharp

Code	Description
FMI-OP/25	114mm long
FMI-OP/25a	140mm long
FMI-OP/25b	160mm long

Code	Description
FMI-OP/26	Straight/blunt, 114mm long
FMI-OP/27	Straight/sharp, 114mm long
FMI-OP/27c	Straight/sharp, 180mm long

With cutout, 110mm long

Code	Description
FMI-OP/27a	Straight/blunt
FMI-OP/27b	Curved/blunt

Strabismus Scissors

Supercut

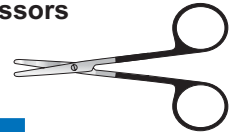

114mm long

Code	Description
FMI-GI/475	Straight
FMI-GI/475a	Curved

Iris Scissors

Supercut

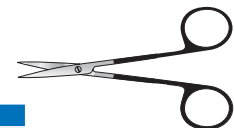

114mm long

Code	Description
FMI-OP/476	Straight
FMI-OP/476a	Curved

Bruce Clarke Needle Holder

Screw joint

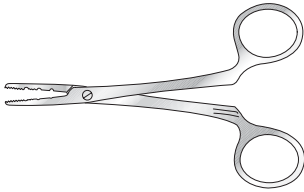

Code	Description
FMI-GI/205	127mm long

Lawrence Needle Holder

Fine jaw, 150mm long

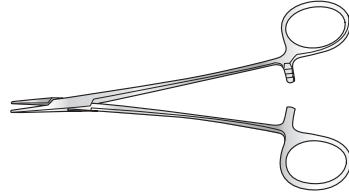

Code	Description
FMI-PL/012a	
FMI-PL/012b	Tungsten carbide jaw

Crile-Wood Needle Holder

Straight, baby, fine

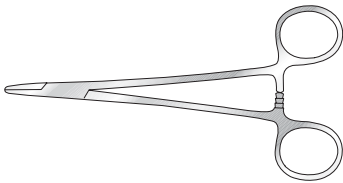

Code	Description
FMI-GI/199	150mm long

Needle Holder

Regular pattern, box joint, lightweight, with curved plain jaws and one oset bow for thumb

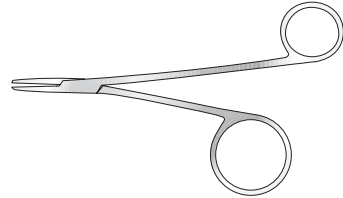

Code	Description
FMI-GI/209	152mm long

Kilner Needle Holder

Box joint, cross-serrated jaw

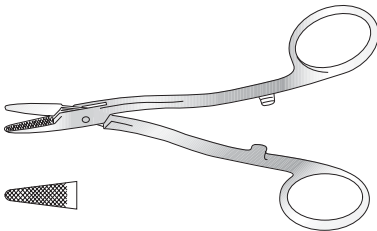

Code	Description
FMI-GI/200	165mm long
FMI-GI/201	133mm long

MacPhail Needle Holder

Screw joint, with one copper jaw

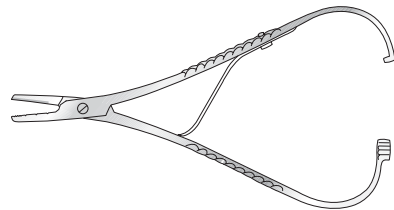

Code	Description
FMI-GI/206	159mm long
FMI-GI/207	178mm long
FMI-GI/208	209mm long

Mathieu Needle Holder

Screw joint

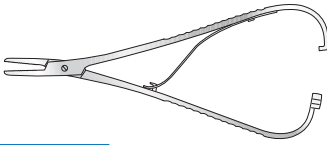

Code	Description
FMI-GI/210	172mm long
FMI-GI/211	209mm long
FMI-GI/212	243mm long

Naughton Morgan Needle Holder

Box joints, cross serrated jaws

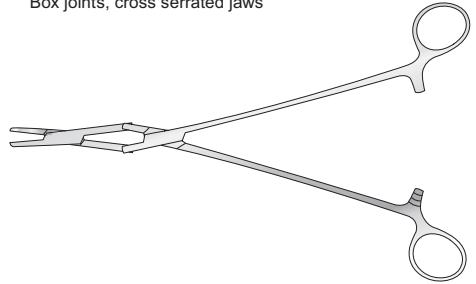

Mayo Needle Holder

Box joint, straight

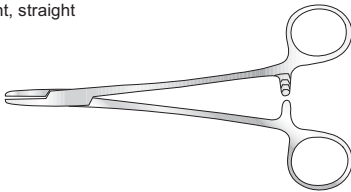

Wide cross serrated jaws

Code	Description
FMI-GI/224	159mm long
FMI-GI/398	203mm long

Narrow cross serrated jaws

Code	Description
FMI-GI/225	159mm long

Tungsten carbide

Code	Description
FMI-GI/399	185mm long
FMI-GI/400	254mm long

Code	Description
FMI-GI/401	185mm long
FMI-GI/402	254mm long

Rochester-Mayo Needle Holder

Screw joint

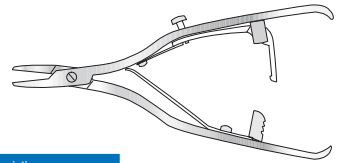

Code	Description
FMI-GI/213	178mm long

Choosing the most suitable needle size

Our tungsten carbide inserts are available in a variety of styles. Choosing the most suitable needle size for each procedure helps give the surgeon maximum grip and control.

Coarse 0.65mm

For powerful needle holder patterns and wire twisters. Maximum holding capabilities for heavy needles or wire.

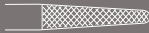

Micro 0.2-0.3mm

For micro needle holders such as Castroviejo, Microvascular and Mini-Ryder. For delicate needles and sutures between 7-0 and 10-0.

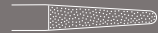

Standard 0.5mm

Used, for example, in Mayo-Hegar, Mathieu Needle Holders. For needles 3-0 and larger.



Smooth

Smooth tungsten carbide surface reduces damage to delicate needles and suture of 6-0 and finer.



Fine 0.4mm

For delicate needle holders such as Crile-Wood and DeBakey. For needles and sutures between 4-0 and 6-0.



Berry Needle Holder/Wire Twister

Tungsten carbide jaws

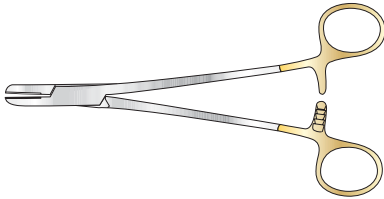

Code	Description
FMI-GI/467	200mm long

Finochietto Needle Holder

Tungsten carbide jaws

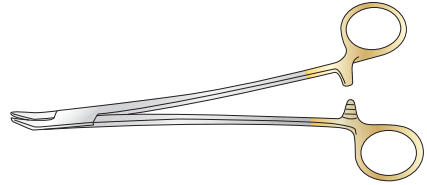

Code	Description
FMI-GI/222	215mm long
FMI-GI/223	265mm long

Crile-Wood Needle Holder

Tungsten carbide insert, box joint, satin finish, straight

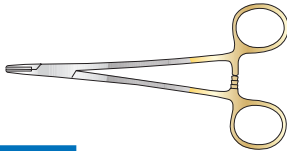

Code	Description
FMI-GI/217	159mm long
FMI-GI/218	178mm long
FMI-GI/198	150mm long

Halsey Needle Holder

Tungsten carbide insert, box joint, satin finish, straight

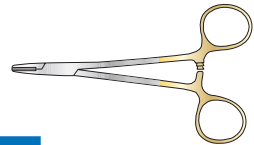

Code	Description
FMI-GI/220	127mm long

Derf Needle Holder

Tungsten carbide insert



Code	Description
FMI-GI/BUHPHF002	115mm long

Kilner Needle Holder

Tungsten carbide insert

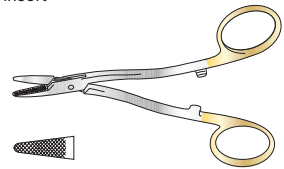

Code	Description
FMI-GI/221	140mm long

Masing Needle Holder

Tungsten carbide insert, one angled bow

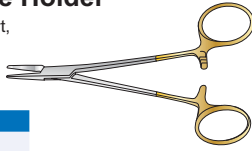

Code	Description
FMI-GI/009R	130mm long

Nievert Needle Holder

Tungsten carbide insert, box joint, satin finish, straight

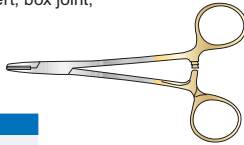

Code	Description
FMI-GI/219	127mm long

Ryder Needle Holder

Tungsten carbide insert, box joint, satin finish, straight

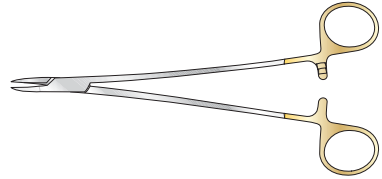

0.2mm jaw pitch

Code	Description
FMI-GI/SH-5197a	135mm long
FMI-GI/SH-5197b	155mm long
FMI-GI/SH-5197c	175mm long
FMI-GI/SH-5197d	210mm long

0.4mm jaw pitch

Code	Description
FMI-GI/SH-5198a	135mm long
FMI-GI/SH-5198b	155mm long
FMI-GI/SH-5198c	175mm long
FMI-GI/SH-5198d	210mm long

DeBakey Needle Holder

250mm long

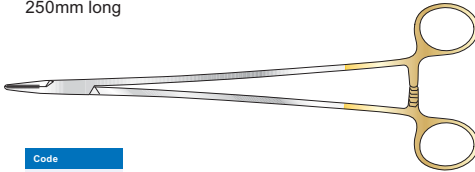

Code
THQ/FMI-5642a

Sarot Needle Holder

Diamond jaw, tungsten carbide, gold plated bows

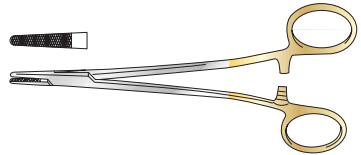

Code	Description
FMI-GI/451	181mm long

Mayo-Hegar Needle Holder

Tungsten carbide insert, box joint, satin finish, straight

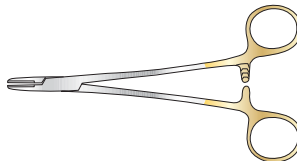

Code	Description
FMI-GI/472	130mm long
FMI-GI/214	159mm long
FMI-GI/215	178mm long
FMI-GI/216	209mm long

Olsen-Hegar Scissor/Needle Holder

With tungsten carbide insert

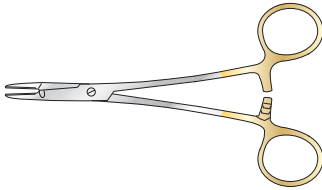

Code	Description
FMI-GI/229	147mm long
FMI-GI/230	165mm long

Olsen-Hegar Scissor/Needle Holder

Screw joint

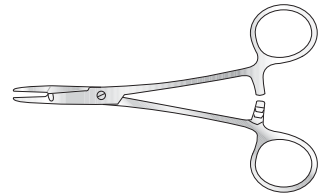

Code	Description
FMI-GI/226	140mm long
FMI-GI/227	165mm long
FMI-GI/228	190mm long

Gillies Scissor/Needle Holder

Right-hand, with tungsten carbide insert



Code	Description
FMI-GI/235	158mm long

Gillies Scissor/Needle Holder

Heavy pattern, 158mm long

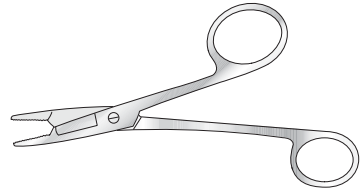

Code	Description
FMI-GI/233	Right-hand
FMI-GI/234	Left-hand

Gillies Scissor/Needle Holder

158mm long

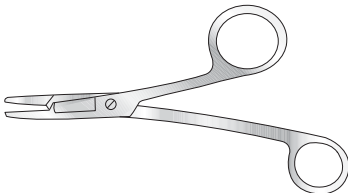

Code	Description
FMI-GI/231	Right-hand
FMI-GI/232	Left-hand

Foster Gillies Scissor/Needle Holder

Fine pattern

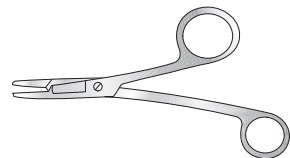

Code	Description
FMI-GI/236	127mm long

Spring Clip

Serrated pattern, stainless steel, for fixing slings to leg splints, also for towel clipping

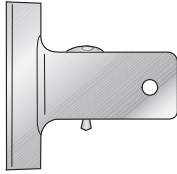

Code	Description
FMI-GI/344	63mm wide

Spring Bag Clip

Serrated



Code	Description
FMI-GI/345	26mm wide

Jones Towel Clip

Superior quality spring forcep type

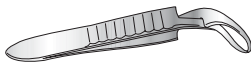

Code	Description
FMI-GI/346	89mm long

Shardles Towel Clip

Spring curved, cross action

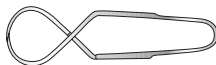

Code	Description
FMI-GI/347	77mm long

Backhaus Towel Clip

Superior quality, box joint

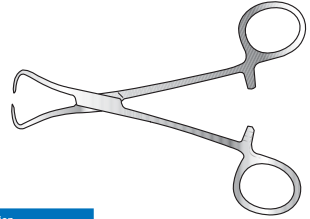

Code	Description
FMI-GI/348	89mm long
FMI-GI/348a	102mm long
FMI-GI/349	130mm long

Moynihan Towel Clip

Screw joint, 2-2 teeth, for sides of incision

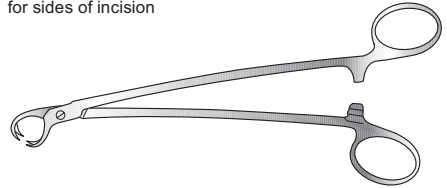

Code	Description
FMI-GI/470	191mm long

Ball and Socket Towel Forceps

Box joint

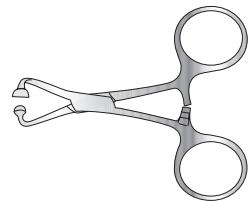

Code	Description
FMI-GI/350	89mm long
FMI-GI/351	115mm long
FMI-GI/352	140mm long

Goligher Retractor

Complete with 2 centre blades:
 1 x 90mm wide x 50mm deep
 1 x 90mm wide x 90mm deep

and 2 pairs of lateral blades:
 1 pair 25mm wide x 45mm deep
 1 pair 50mm wide x 90mm deep

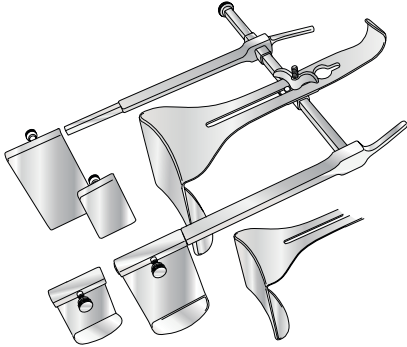

Code
FMI-GI/305

Balfour Abdominal Retractor

Trivalve, frame 203mm

Child

102mm opening, 51mm deep lateral blades,
 38mm deep centre blade

Adult

178mm opening, 64mm deep lateral blades,
 44mm deep centre blade

Extra large

178mm opening, 102mm deep lateral blades,
 108mm deep centre blade

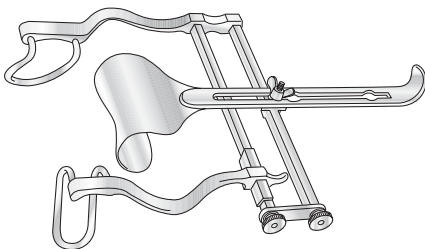

Code	Description
FMI-GI/373	Child
FMI-GI/374	Adult
FMI-GI/375	Extra large

Miles Retractor

Complete with 2 centre blades:
 1 x 90mm wide x 50mm deep
 1 x 90mm wide x 75mm deep

and 2 pairs of lateral blades:
 1 pair 80mm wide x 35mm deep
 1 pair 80mm wide x 75mm deep

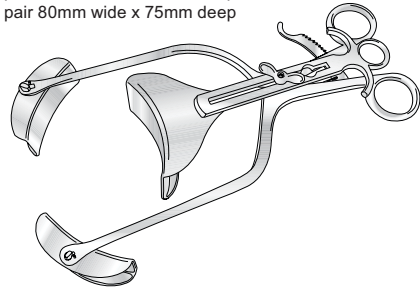

Code	Description
FMI-GI/376	340mm long

Balfour Abdominal Retractor

Bivalve, baby

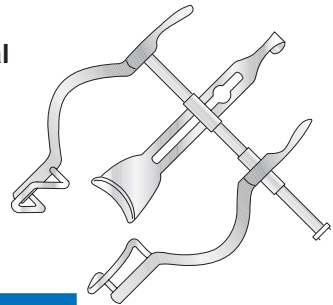

Code	Description
FMI-GI/372	Fully open 89mm

Berkeley Abdominal Retractor

Parallel action

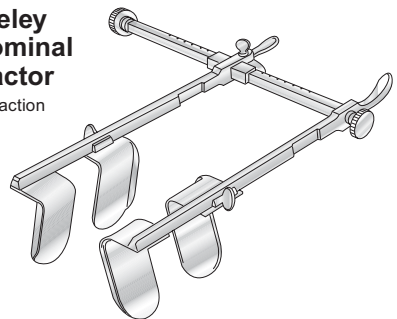

Code	Description
FMI-GI/461	Blades 35mm x 60mm deep, 215mm long

Turner Warwick Universal Self Retaining Retractor

Code	Description
FMI-GI/520	With frames A/B/C/D and blades A/B/C/D/E/F/K/L
FMI-GI/521-A	Circular frame A only 178mm
FMI-GI/521-B	Circular frame B only 229mm
FMI-GI/521-C	Circular frame C only 305mm
FMI-GI/521-D	Oval frame D only 475mm x 330mm
FMI-GI/521-E	Oval frame E only 370mm x 300mm

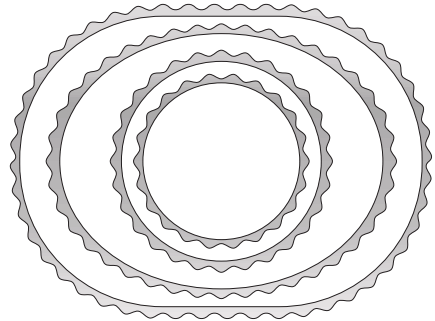

Turner Warwick Needleholder with Tungsten Carbide Jaws

Curved shanks with one short bow

Code	Description
FMI-5835	230mm long
FMI-5835A	200mm long

Blade A



Code	Description
FMI-GI/522-A	Blade only - 19mm x 76mm

Blade B

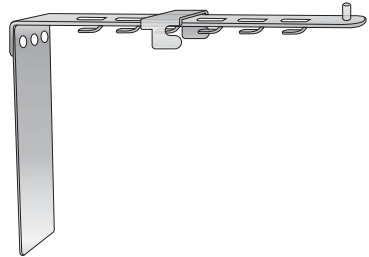

Code	Description
FMI-GI/522-B	Blade only - 38mm x 102mm

Blade C

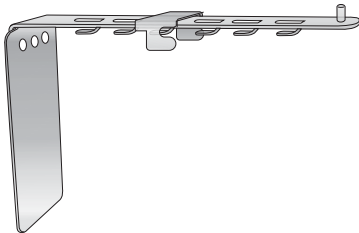

Code	Description
FMI-GI/522-C	Blade only - 57mm x 89mm

Blade D

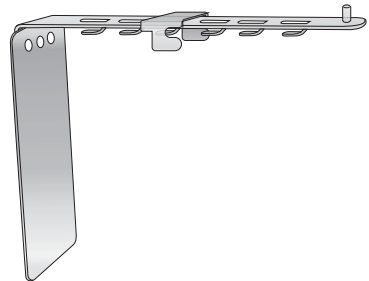

Code	Description
FMI-GI/522-D	Blade only - 57mm x 114mm

Blade E

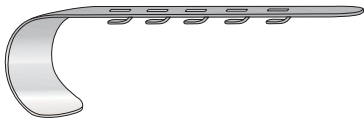

Code	Description
FMI-GI/522-E	Blade only - curved stainless steel blade 51mm x 38mm

Blade F

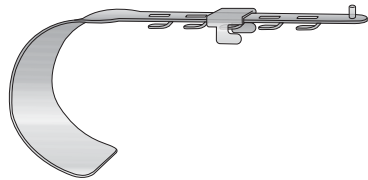

Code	Description
FMI-GI/522-F	Blade only - curved stainless steel blade 76mm x 60mm

Blade G

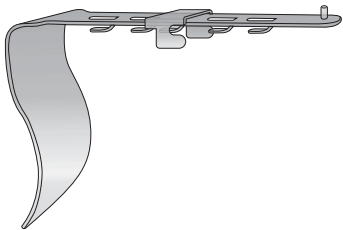

Code	Description
FMI-GI/522-G	Blade only - flat stainless steel blade 89mm x 60mm

Blade J



Code	Description
FMI-GI/522-J	Blade only - single hook, 13mm deep

Blade K

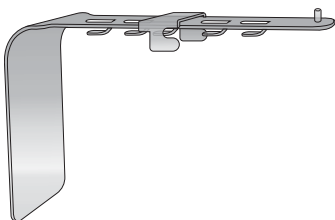

Code	Description
FMI-GI/522-K	Blade only - flat with clip 55mm x 90mm

Blade L

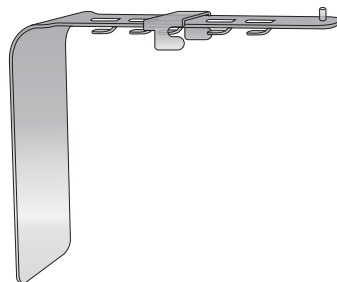

Code	Description
FMI-GI/522-L	Blade only - flat with clip 55mm x 120mm

Collin Retractor

110mm fully open, 235mm long

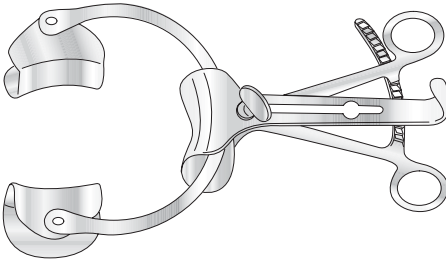

Code	Description
FMI-GI/322	Complete with centre blade 55 x 40mm and one pair of blades 38mm x 60mm
FMI-GI/322a	Without centre blade

Gelpi Retractor

Self retaining

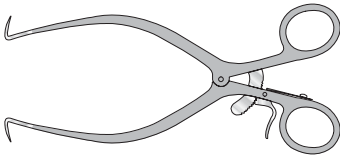

Code	Description
FMI-GY013a	140mm long
FMI-GY013b	178mm long

Joll Thyroid Retractor

Self retaining, with lock-in nut

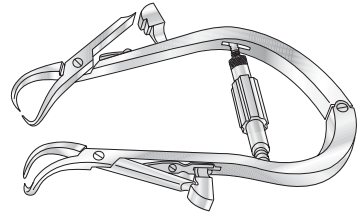

Code	Description
FMI-GI/363	152mm long

Gossett Abdominal Retractor

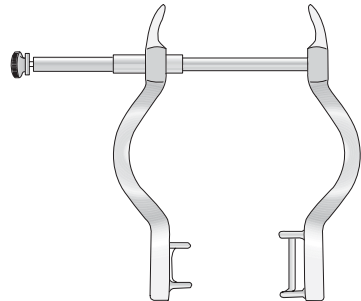

Code	Description
FMI-GI/303	Large, fully open 185mm long
FMI-GI/304	Small, fully open 95mm long

Pozzi Abdominal Retractors

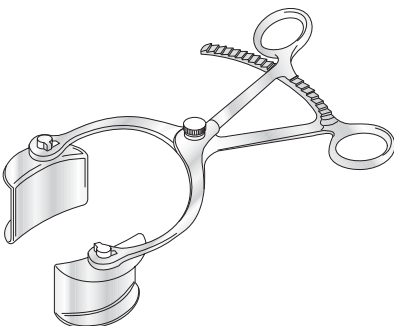

Code	Description
FMI-GI/370	Swivel blades: 38 x 60mm, bivalve, 254mm long

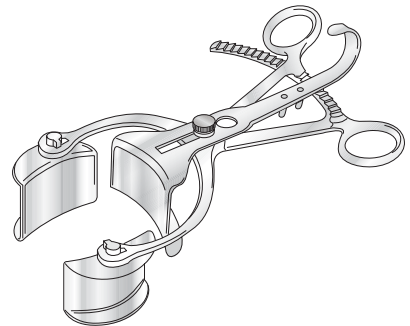

Code	Description
FMI-GI/371	Swivel blades: 38 x 59mm, trivalve, 203mm long

Bowlby Dilator

Curved

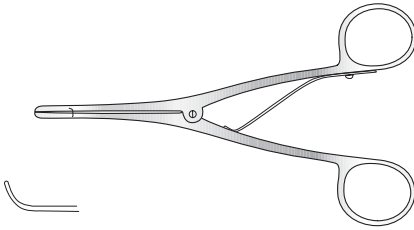

Code	Description
FMI-GI/495	145mm long

Travers Retractor

Self retaining with internal rack, 210mm long

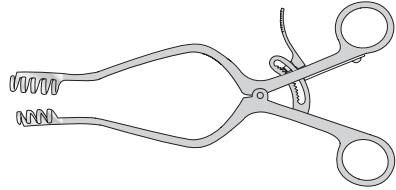

Code	Description
FMI-GI/323	4 x 5 teeth, 95mm fully open

Irwin Retractor

Self retaining, with cam rack, 4 x 4 teeth

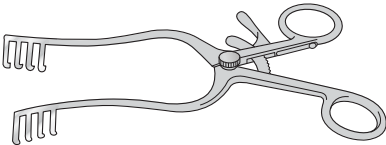

Code	Description
FMI-GI/324	178mm long

West Retractor

Self retaining, 140mm long

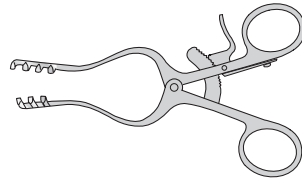

Code	Description
FMI-GI/326	3 x 4 teeth, 60mm fully open
FMI-GI/326c	3 x 4 teeth, 60mm fully open, with cam rack

Norfolk and Norwich Retractor

4 x 5 teeth 50mm blades x 223mm long

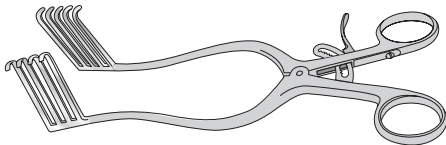

Code	Description
FMI-GI/325	Standard rack

Weitlander Retractor

3-4 teeth

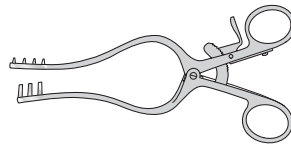

135mm long

Code	Description
FMI-GI/496	Blunt
FMI-GI/496a	Sharp
FMI-GI/496b	Sharp, 2-3 teeth
FMI-GI/496c	Blunt, 2-3 teeth

165mm long

Code	Description
FMI-GI/497	Blunt
FMI-GI/497a	Sharp

Kocher Retractor

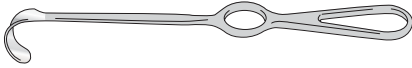

230mm long

Code	Description
FMI-GI/378	36 x 20mm blade

250mm long

Code	Description
FMI-GI/378a	67 x 25mm blade
FMI-GI/378b	80 x 42mm blade
FMI-GI/378c	80 x 50mm blade
FMI-GI/378d	80 x 60mm blade

Kocher Langenbeck Retractor

215mm long



Code	Description
FMI-GI/336sp	25 x 6mm blade
FMI-GI/379a	35 x 8mm blade
FMI-GI/379b	35 x 11mm blade
FMI-GI/379c	35 x 15mm blade
FMI-GI/379p	41 x 11mm blade

Code	Description
FMI-THO/cutsp015	55 x 11mm blade
FMI-GI/379d	70 x 15mm blade
FMI-GI/379e	80 x 12mm blade
FMI-GI/379f	80 x 16mm blade

Langenbeck Retractor

Single ended



Code	Description
FMI-GI/336	Blade 22mm x 6mm
FMI-GI/337	Blade 45mm x 13mm
FMI-GI/337a	Blade 65mm x 13mm
FMI-GI/338a	Blade 75mm x 25mm
FMI-GI/338a1	Blade 65mm x 25mm

Landon Retractor



Code	Description
FMI-GI/494	230mm



Canny Ryall Navy Retractor

Double-ended, with one single hook blade 5mm wide, and one fenestrated blade

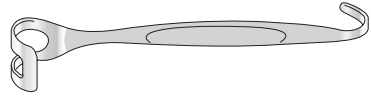

Code	Description
FMI-GI/343	Fenestrated blade 16mm wide, 190mm long
FMI-GI/343a	Fenestrated blade 19mm wide, 190mm long
FMI-GI/343b	Fenestrated blade 25mm wide, 220mm long
FMI-GI/343c	Fenestrated blade 30mm wide, 220mm long

Canny Ryall Army Retractor

Double prong, 13mm wide, 165mm long



Code	Description
FMI-GI/342	Large, 19mm wide
FMI-GI/342a	Small, 11mm wide



Czerny Retractor

Double ended

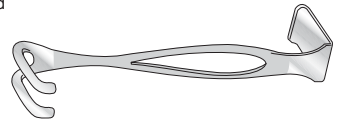

Code	Description
FMI-GI/341	171mm long

Lane Retractor

Double ended blade, 229mm long

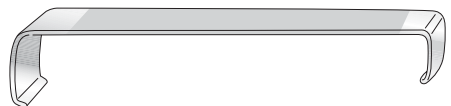

Code	Description
FMI-GI/339	13mm x 19mm wide
FMI-GI/340	25mm x 32mm wide

Morris Retractor

Single blade, 229mm long

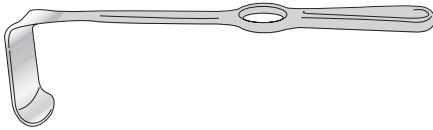

Code	Description
FMI-GI/330	38 x 51mm
FMI-GI/331	51 x 51mm
FMI-GI/332	64 x 51mm

Morris Retractor

Double ended, 216mm long

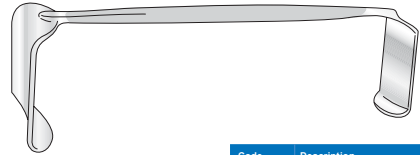

Code	Description
FMI-GI/327	32 x 51mm and 38 x 51mm
FMI-GI/328	44 x 51mm and 51 x 51mm
FMI-GI/329	64 x 51mm and 38 x 51mm

Moynihan Retractor



Code	Description
FMI-GI/462	Single ended, blade 13 x 22mm, 215mm long

Deaver Abdominal Retractors



Code	Description
FMI-GI/306	Set of 5, 315mm overall length
FMI-GI/307	25mm wide
FMI-GI/308	25mm wide
FMI-GI/309	38mm wide
FMI-GI/310	51mm wide
FMI-GI/311	76mm wide

Elliot (Modified Deaver) Retractor



Code	Description
FMI-GI/308M	With flat handle

Dyball and Lock Retractor

For liver

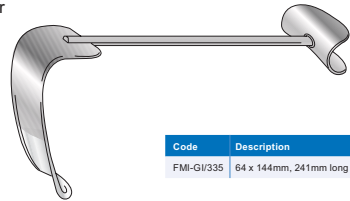

Code	Description
FMI-GI/335	64 x 144mm, 241mm long

Deaver Abdominal Retractors

With round handles

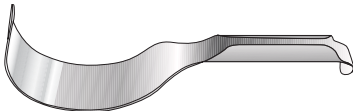

Code	Description
FMI-GI/312	Set of 5, 305mm overall length
FMI-GI/313	25mm wide
FMI-GI/314	25mm wide
FMI-GI/315	38mm wide
FMI-GI/316	51mm wide
FMI-GI/317	76mm wide

Kelly Retractor Blade

267mm long

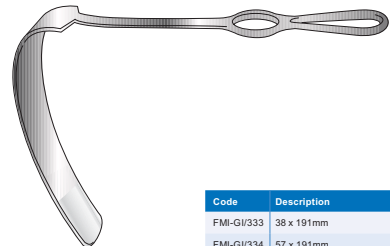

Code	Description
FMI-GI/333	38 x 191mm
FMI-GI/334	57 x 191mm

Durham Retractor

With fenestrated blade, 216mm long

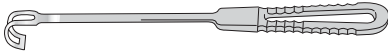

Code	Description
FMI-GI/300	10mm wide
FMI-GI/301	14mm wide
FMI-GI/302	20mm wide

Ballance (Volkman) Retractor

203mm long



Sharp

Code	Description
FMI-GI/463	1 prong
FMI-GI/463a	2 prong
FMI-GI/463b	3 prong
FMI-GI/463c	4 prong
FMI-GI/463d	6 prong

Blunt

Code	Description
FMI-GI/463e	1 prong
FMI-GI/463f	2 prong
FMI-GI/463g	3 prong
FMI-GI/463h	4 prong
FMI-GI/463i	6 prong

Volkman Retractor



Code	Description
FMI-OR/400	Sharp, 220mm long
FMI-OR/400a	Blunt, 220mm long
FMI-OR/400b	Sharp, 245mm long

Kilner Retractor

Double ended, cat's paw



Code	Description
FMI-PL/056	152mm long

Kocher Retractor



Code	Description
FMI-OR/N036c	Sharp, 205mm long
FMI-OR/N036	Sharp, 220mm long
FMI-OR/N036b	Blunt, 220mm long

Senn-Miller Retractor

170mm long



Code
FMI-SH/5881

Single Hook Retractor

Sharp



Code	Description
FMI-GI/SH5671	152mm long
FMI-PL/065b	Half size, fine

Gillies Skin Hook

Solid handle, 190mm long



Code	Description
FMI-PL/065a	Standard, fine
FMI-PL/065b	Half size, fine

MacDonald Dissector Double Ended Probe, Sinus Silver



Code	Description
FMI-GI/285	191mm long



Code	Description
FMI-GI/464	152mm long

Brodie Director Probe Ended, Silver Plated



Code	Description
FMI-GI/286	165mm long

Probe, Fish Tail Silver Plated



Code	Description
FMI-GI/293	127mm long
FMI-GI/294	152mm long
FMI-GI/295	203mm long
FMI-GI/296	254mm long

Watson Cheyne Dissector

Fine, double-ended, with probe end



Code	Description
FMI-GI/287	127mm long
FMI-GI/288	191mm long
FMI-GI/288a	230mm long
FMI-GI/288b	255mm long

Jobson Horne Probe Dressing (Aural)

With one flat tapered end, serrated edge and one small ring end, stainless steel



Code	Description
FMI-GI/297	140mm long
FMI-GI/298	178mm long

Probe, Malleable Silver Plated



Code	Description
FMI-GI/289a	127mm long
FMI-GI/289	152mm long
FMI-GI/290	178mm long
FMI-GI/291	203mm long
FMI-GI/292	255mm long
FMI-GI/292a	305mm long

Aneurysm Needle

Small, for infusions



Code	Description
FMI-GI/472a	148mm long

Syme Aneurysm Needle



Code	Description
FMI-GI/473	165mm long

Ring Cutter

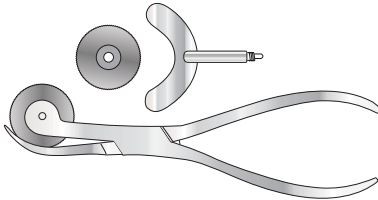

Code	Description
FMI-GI/452	Circular saw blade, 165mm long
FMI-GI/452a	Spare blade

Mayo Instrument Pin

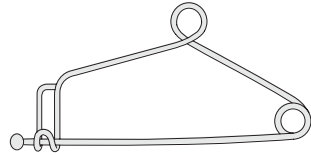

Code	Description
FMI-GI/355	102mm long
FMI-GI/356	152mm long

Baron Scalpel Handle

130mm long



Code	Description
FMI-PM/003	No 3
FMI-PM/004	No 4

Scalpel Handle

127mm long

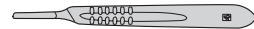

Code	Description
FMI-PM/007	No 3
FMI-PM/008	No 4
FMI-PM/008a	No 4 L
FMI-PM/001a	No 7

Kidney Dish

Stainless steel

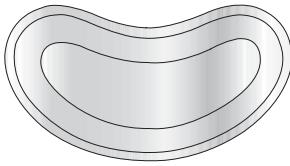

Code	Description
FMI-GI/380	152mm
FMI-GI/381	203mm
FMI-GI/382	254mm
FMI-GI/383	305mm

Lotion Bowl

Without lid, stainless steel

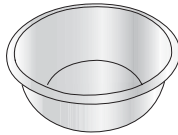

Code	Description
FMI-GI/384	102mm
FMI-GI/385	152mm
FMI-GI/386	203mm
FMI-GI/387	254mm
FMI-GI/388	305mm

Instrument Tray

Stainless steel

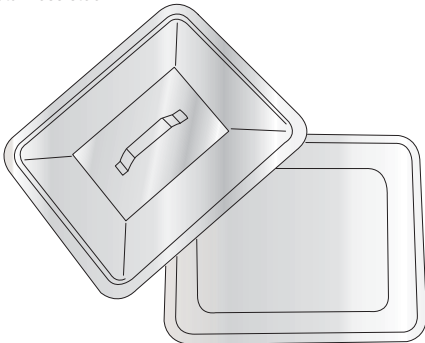

Code	Description
FMI-GI/389	254 x 203 x 50mm
FMI-GI/390	Lid only for 254 x 203 x 50mm
FMI-GI/391	305 x 254 x 50mm
FMI-GI/392	Lid only for 305 x 254 x 50mm
FMI-GI/393	356 x 305 x 50mm
FMI-GI/394	Lid only for 356 x 305 x 50mm

Cheate Jar

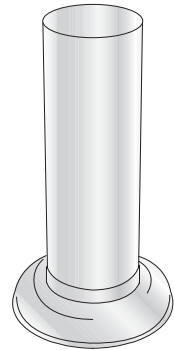

Code	Description
FMI-GI/397	Stainless steel, 203mm x 50mm

Measuring Jug



Code	Description
FMI-GI/395	1 litre capacity

Petri Dish



Code	Description
FMI-SH/002149	100mm, stainless steel, with lid

Gallipot

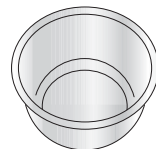

Code	Description
FMI-GI/396	Stainless steel, 63mm

Silicone Matting

Medical grade for storage, sterilisation and transportation of instruments.

Cushion, protect, and organise delicate surgical instruments during storage, transportation, and sterilisation. Perforations allow for ventilation during the sterilisation process. The silicone mat can be cut to fit any size container.

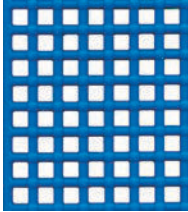

502mm long x 242mm wide
7mm holes, 10mm between holes

Code
FMI-1004M

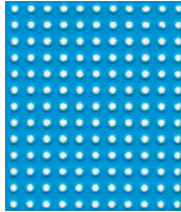

515mm long x 240mm wide
3mm holes, 6mm between holes

Code
FMI-1001M

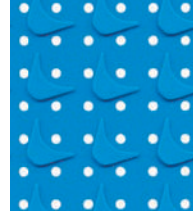

570mm long x 550mm wide
4mm holes, 13mm between holes

Code
FMI-1002M

Sterilising Baskets

DIN Basket

Wire mesh base with perforated sides and two carrying handles

Code	Description
FMI-GI/CO006	230 x 130 x 60mm
FMI-GI/CO007	240 x 130 x 50mm
FMI-GI/CO008	240 x 130 x 60mm
FMI-GI/CO009	240 x 250 x 50mm
FMI-GI/CO010	240 x 250 x 60mm
FMI-GI/CO014	300 x 300 x 50mm
FMI-GI/CO015	350 x 350 x 60mm
FMI-GI/CO011	480 x 250 x 50mm
FMI-GI/CO012	480 x 250 x 60mm

Code	Description
FMI-GI/CO013	480 x 250 x 70mm
FMI-GI/CO016	480 x 400 x 60mm
FMI-GI/CO017	480 x 480 x 50mm
FMI-GI/CO018	480 x 480 x 60mm
FMI-GI/CO019	500 x 300 x 50mm
FMI-GI/CO020	550 x 430 x 50mm
FMI-GI/CO021	600 x 300 x 60mm



DIN Basket

Wire mesh basket with two carrying handles

Code	Description
FMI-GI/CO022	240 x 250 x 50mm
FMI-GI/CO023	240 x 250 x 60mm
FMI-GI/CO024	240 x 250 x 70mm
FMI-GI/CO031	300 x 300 x 60mm
FMI-GI/CO025	480 x 250 x 50mm

Code	Description
FMI-GI/CO026	480 x 250 x 60mm
FMI-GI/CO027	480 x 250 x 70mm
FMI-GI/CO028	480 x 250 x 100mm
FMI-GI/CO029	480 x 480 x 50mm
FMI-GI/CO030	480 x 480 x 70mm

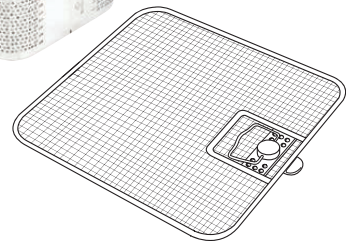

DIN Basket Lids

For perforated and wire mesh baskets

Code	Description
FMI-GI/CO032	240 x 250mm
FMI-GI/CO033	300 x 300mm
FMI-GI/CO034	480 x 250mm
FMI-GI/CO035	480 x 480mm

ENT Basket

Wire mesh base with perforated sides and two carrying handles, supplied with lid

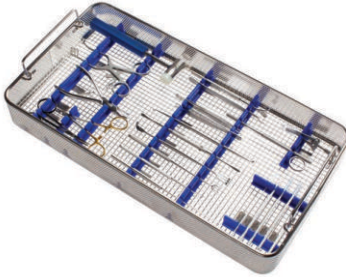

Code	Description
FMI-GI/CO036	480 x 250 x 160mm
FMI-GI/CO037	Fixing clamps

Arthroscope Basket

Wire mesh base with two fixing clamps

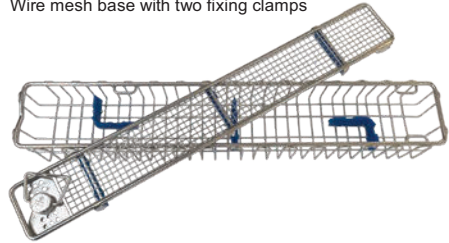

Code	Description
FMI-GI/CO001	290 x 80 x 52mm

Endoscope Basket

With small lens basket

Code	Description
FMI-GI/CO002	6400 x 150 x 77mm

Wire mesh base with two fixing clamps

Code	Description
FMI-GI/CO003	S - 460 x 80 x 52mm
FMI-GI/CO004	D - 480 x 80 x 52mm
FMI-GI/CO005	D - 680 x 80 x 52mm

Sieve

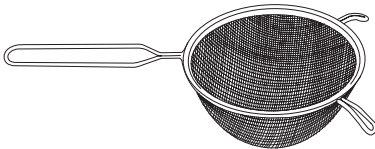

Code	Description
FMI-GI/5071	203mm x 50mm ø

Fine Mesh Basket



With hinged take off / lockable lid

Code	Description
FMI-GI/CO041	120 x 155 x 40mm
FMI-GI/CO044	120 x 155 x 50mm
FMI-GI/CO042	235 x 155 x 40mm
FMI-GI/CO045	235 x 155 x 50mm
FMI-GI/CO043	375 x 260 x 40mm

With separate lid

Code	Description
FMI-GI/CO038	120 x 155 x 40mm
FMI-GI/CO039	235 x 155 x 40mm
FMI-GI/CO040	375 x 260 x 40mm